

Rev.	ECN Number	Description	Date	Drawn	Checkd	Approved

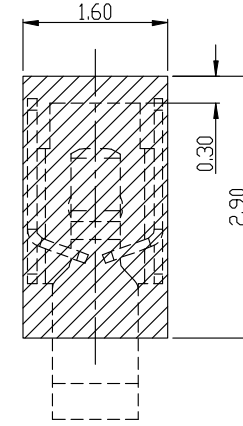

RECOMMENDED PCB LAYOUT
TOLERANCE ±0.05MM

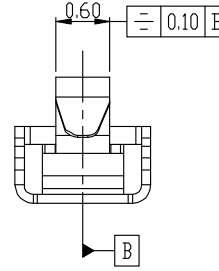
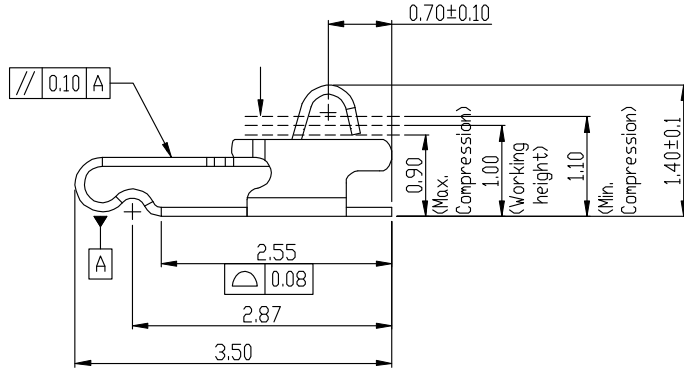
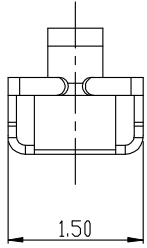
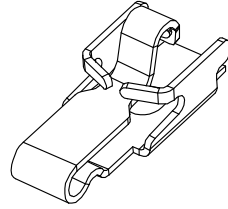
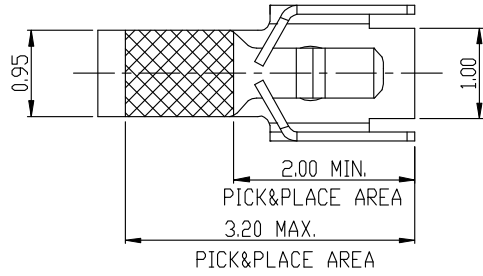
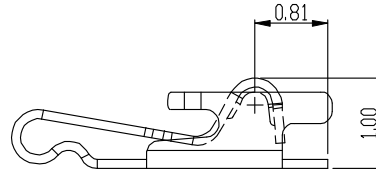
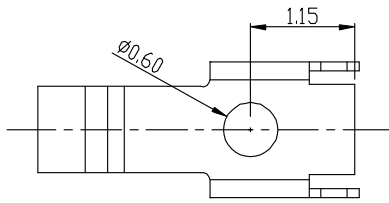

State at
working height 1.00mm

LANGDUN

GENERAL TOLERANCE	
XX. ±0.50	
X. ±0.35	X.° ±2.0°
.X ±0.25	.X° ±1.0°
.XX ±0.15	.XX° ±0.5°

SCALE:	1:1
UNIT:	mm
SIZE:	A4



DRAWN	Chen	DATE	2013. 4. 03
CHECK		DATE	
APPROVE		DATE	

DWG. NO.	
PARTS NO.(INTENDED USE)	AS-034

TITLE	RF Antenna Spring,SMT, L3.5*W1.5*H1.4mm
-------	--

REV.	A
SHEET	1/2

由 Autodesk 教育版产品制作

Autodesk

由 Autodesk 教育版产品制作

PDF created with pdfFactory Pro trial version www.pdffactory.com