

Rev.	ECN Number	Description	Date	Drawn	Checked	Approved

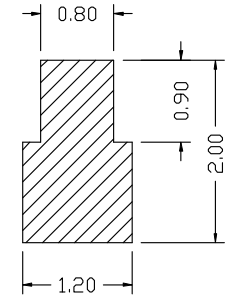

RECOMMENDED PCB LAYOUT
TOLERANCE ±0.05MM

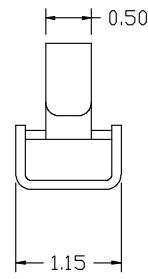
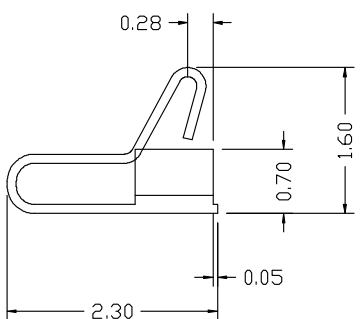
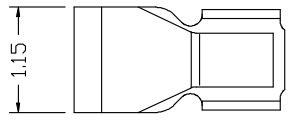
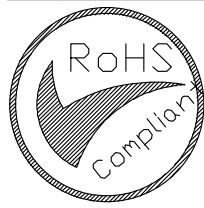
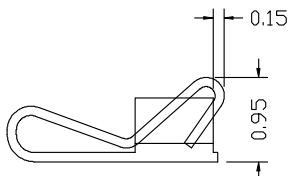

极限压下高度

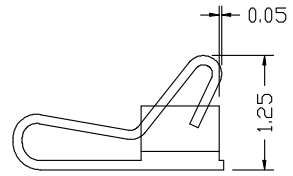

合理工作高度

- NOTES:
- 1: 材质 SUS304
 - 2: 表面处理 整体镀镍 50", 触点与焊盘位置镀金1u"
 - 3: 性能:
接触电阻: 50mΩ MAX.
使用温度: -20° C~+65° C.
工作高度位置接触点压力0.5N
 - 4: 包装.: 卷带包装

朗顿电子

GENERAL TOLERANCE	
XX. ±0.50	
X. ±0.35	X.° ±2.0°
.X ±0.25	.X° ±1.0°
.XX ±0.15	.XX° ±0.5°

SCALE:	1:1
UNIT:	mm
SIZE:	A4

DRAWN	Chen
CHECK	
APPROVE	

DATE	2020. 6. 10
DATE	
DATE	

DWG. NO.	
PARTS NO.(INTENDED USE)	AS-053

TITLE	(CUSTOMER DRAWING) Antenna Spring,SMT, L2.3*W1.1*H1.6mm
-------	---

REV.	A
SHEET	1/1