

F

E

D

C

B

A

RoHS
Compliant

SYMBOL	REVISION	APPROVAL	DATE

1

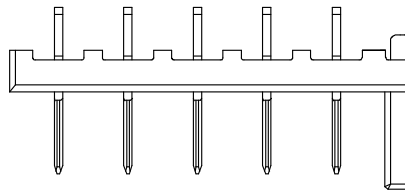
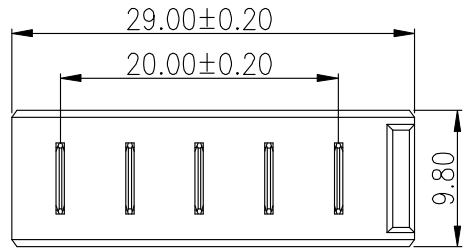

备注:

1. 产品规格:

1-1. 额定电压:30V

1-2. 耐电压:1000V AC MIN.

1-3. 接触阻抗:30mΩ MAX. INITIAL;40mΩ MAX
AFTER 3000 CYCLES

1-4. 绝缘电阻:1000MΩ MIN

1-5. 工作温度:-25°C TO +80°C

2. 材质:

2.1胶芯: PA9T UL94V-0/LCP BLACK

2.2端子: 合金铜, 镍底, GOLD

3. 所用材质须符合RoHS要求

2

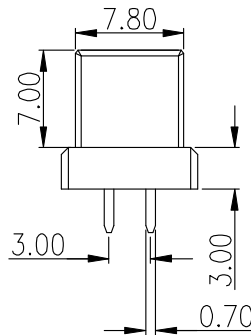
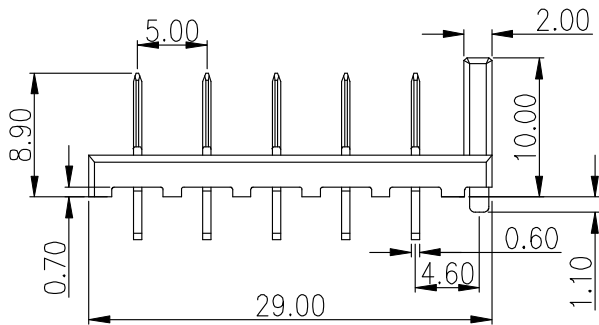

3

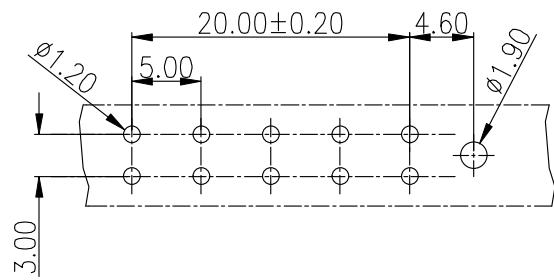
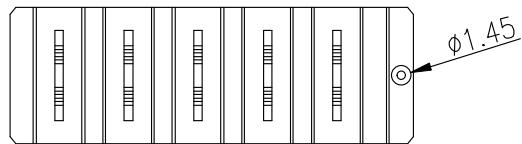
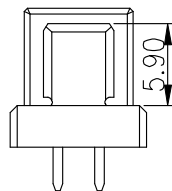

RECOMMENDED P.C. BOARD LAYOUT

4

DISONG ELECTRONIC CO., LTD.

COPYRIGHT RESERVED, PLEASE DO NOT COPY.

PART NAME		CONNECTOR		DRAWING		M.M.Zhang		DWG.No.		JD-009	
PART NO.		LD-C02M-A-5P-R2		CHECK		G.C.Chen		REV.		A1	
UNIT : mm	TOLERANCE OTHERWISE	UP TO 5	±0.2	ANGLE	APPROVAL	SCALE	2:1	DATE	01-07-2016		
		ABOVE 5 & Ø	±0.3						PAGE	1 OF 1	
		ABOVE 30	±0.5	0°±3'							

F

E

D

C

B

A

1

2

3

4