

Rev.	ECN Number	Description	Date	Drawn	Checkd	Approved

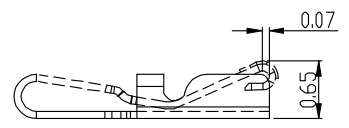
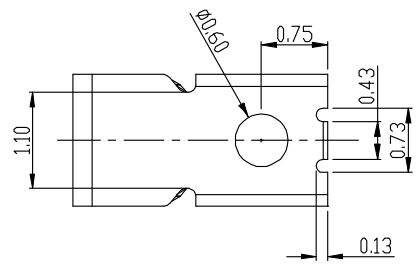
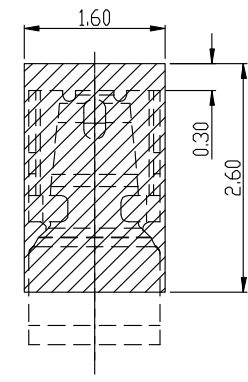
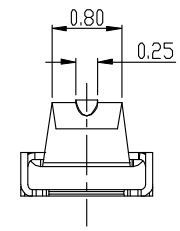
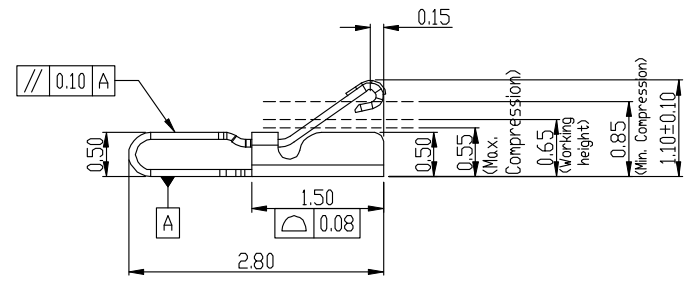
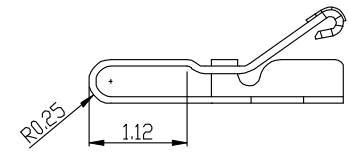
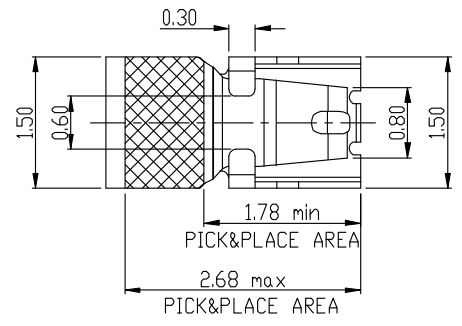

State at working height 0.65mm

LANGDUN

GENERAL TOLERANCE	
XX. ±0.50	
X. ±0.35	X.° ±2.0°
.X ±0.25	.X° ±1.0°
.XX ±0.15	.XX° ±0.5°

SCALE:	1:1
UNIT:	mm
SIZE:	A4

DRAWN	DATE
CHECK	DATE
APPROVE	DATE

DWG. NO.	
PARTS NO.(INTENDED USE)	AS-019

TITLE	客户图
	RF Antenna Spring,SMT, L2.8*W1.5*H1.1mm

REV.	A
SHEET	1/1