

F

E

D

C

B

A

1

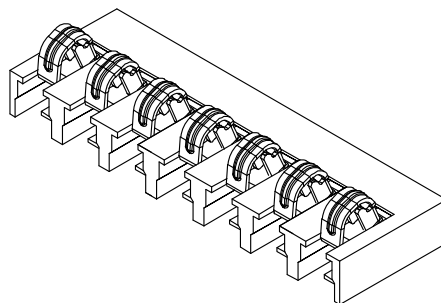
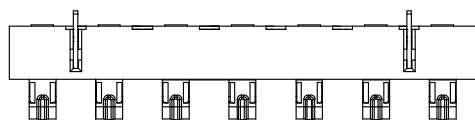

2

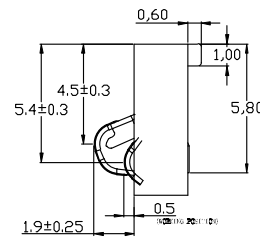
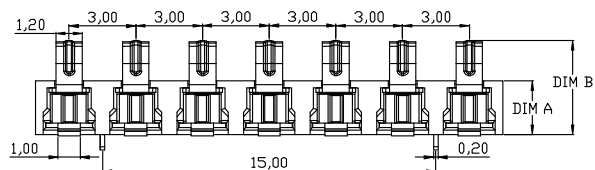

3

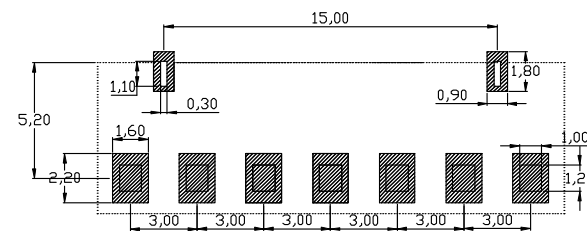
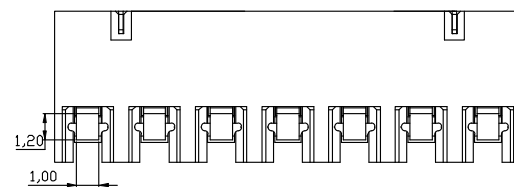
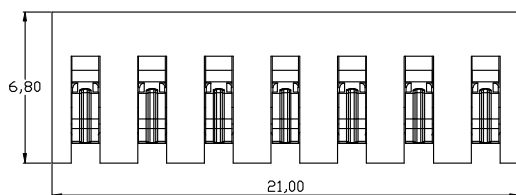

RECOMMENDED PCB LAYOUT
TOP VIEW (.XX±0.05)

4

PART NO.	DIM A	DIM B	2	HOUSING	LCP	1	BLACK
BC-1-704-C01	2.4	4.30±0.25	1	CONTACT TERMINAL	PHOSPHOR BRONZE	3	Au PLATED
BC-1-704A-C01	3.5	5.40±0.25	NO.	PARTS	MATERIAL	QTY.	FINISHING

东莞市朗顿电子科技有限公司

PART NAME		CONNECTOR		DRAWING	G.B.Wu	DWG.No.	DS-BC-111
PART NO.		BC-1-704/704A-C01		CHECK	Q.L.Dai	REV.	A0
UNIT : mm	TOLERANCE	UP TO 5	±0.2	APPROVAL	DATE	PAGE	06-09-2017
	OTHERWISE	ABOVE 5 30 ~	±0.3				
		SCALE	2:1				

COPYRIGHT RESERVED, PLEASE DO NOT COPY.

F

E

D

C

B

A