

F

E

D

C

B

A

1

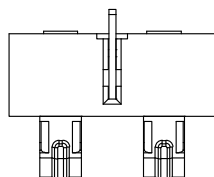
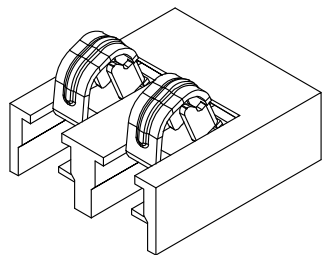

2

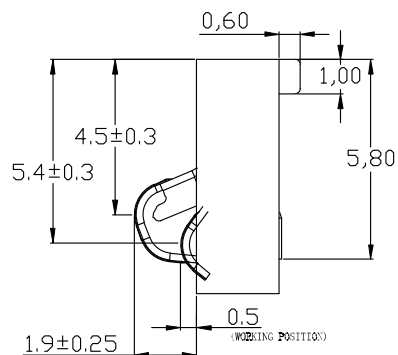
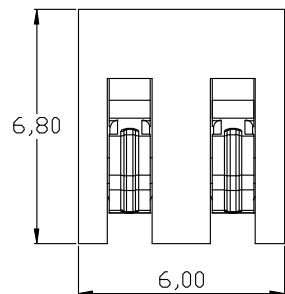

3

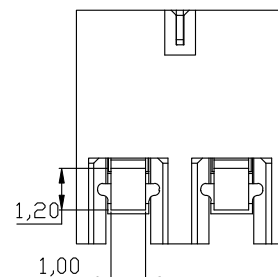
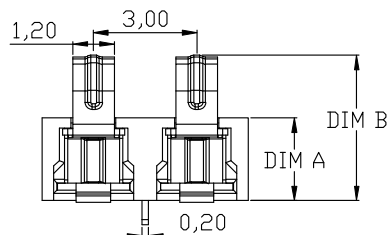

性能:

额定电流: 3.0A

额定电压: 24V

耐电压: 500V

接触电阻: 30mΩ MAX

绝缘电阻: 500MΩ

工作温度: -40℃~+85℃

塑件(材质): LCP, 耐高温260℃

接触点(材质): 铜合金, 触点镀金3U

1

2

3

4

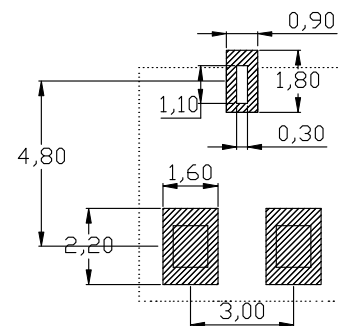

RECOMMENDED PCB LAYOUT  
TOP VIEW (.XX±0.05)

PART NO.	DIM A	DIM B	2	HOUSING	LCP	1	BLACK
BC-1-216-C01	2.4	4.30±0.25	1	CONTACT TERMINAL	PHOSPHOR BRONZE	3	Au PLATED
BC-1-216A-C01	3.5	5.40±0.25	NO.	PARTS	MATERIAL	QTY.	FINISHING

# 东莞市朗顿电子科技有限公司

COPYRIGHT RESERVED, PLEASE DO NOT COPY.

PART NAME		CONNECTOR		DRAWING	G.B.Wu	DWG.No.	DS-BC-111
PART NO.		BC-1-216/216A-C01		CHECK	Q.L.Dai	REV.	A0
UNIT : mm	TOLERANCE	UP TO 5	±0.2	APPROVAL	DATE	PAGE	06-09-2017
	OTHERWISE	ABOVE 5 30 ~	±0.3				
SCALE				2:1			

F

E

D

C

B

A